

BONALDO

Pivot

Designer: Marconato and Zappa



The Pivot table takes its name from the unusual shape of the base: the central leg acts as a pivot for the three legs which extend to the sides. The result is an asymmetric and highly original combination that makes a statement in the room. In this crossed leg dining table, the legs are made of coal oak or solid walnut wood with metal inserts, while the top is available in marble, solid wood, glass and ceramic in the two round and round-edged versions.



Data sheet

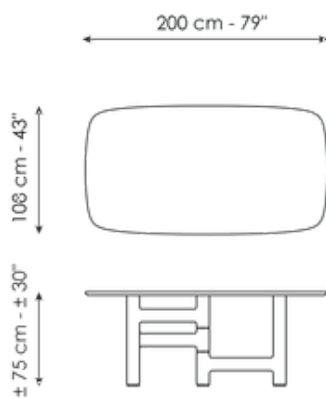

Width: 200cm
Depth: 108cm
Height: ± 75cm

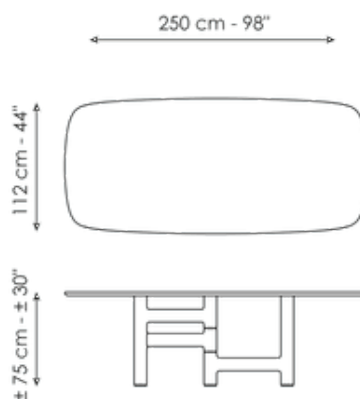

Width: 250cm
Depth: 112cm
Height: ± 75cm

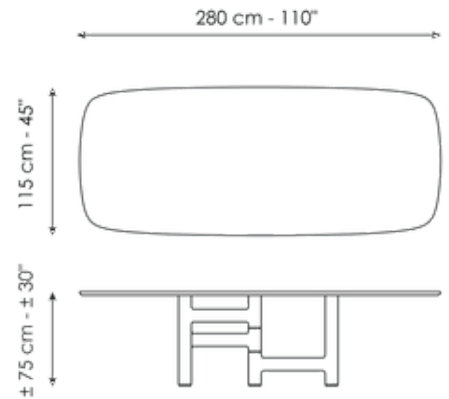

Width: 280cm
Depth: 115cm
Height: ± 75cm

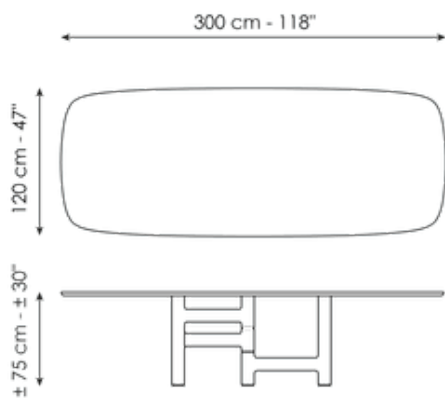

Width: 300cm
Depth: 120cm
Height: ± 75cm

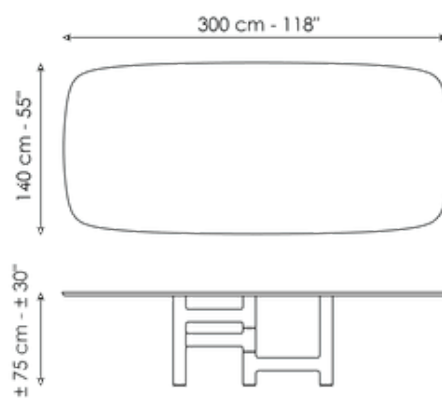

Width: 300cm
Depth: 140cm
Height: ± 75cm

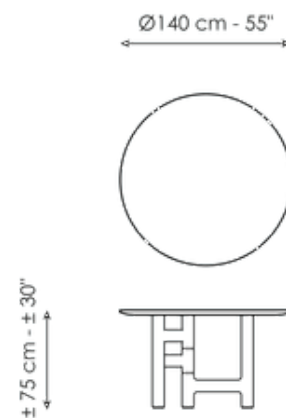

Width: 140cm
Depth: 140cm
Height: ± 75cm

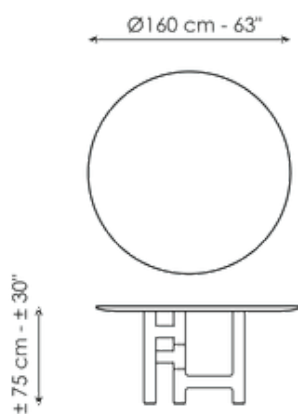

Width: 160cm
Depth: 160cm
Height: ± 75cm

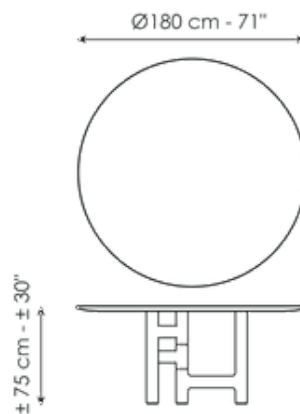

Width: 180cm
Depth: 180cm
Height: ± 75cm

Finishes

Barrel-shaped top



Solid wood
Brushed coal oak

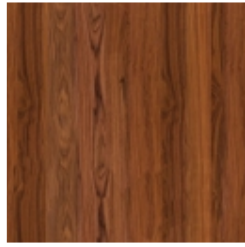

Solid wood
American walnut



Glass
Bronzed



Glass
Smoked

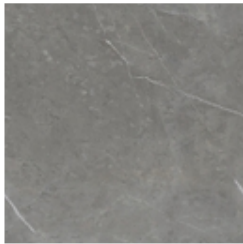

Mat ceramic
Ardesia grey



Glossy ceramic
Calacatta



Silk finish ceramic
Calacatta macchia vecchia

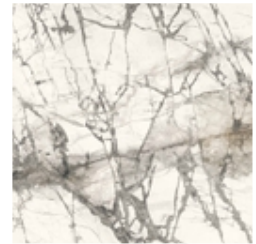

Glossy ceramic
Imperial grey

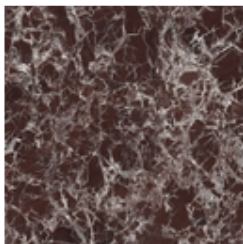

Glossy ceramic
Rosso imperiale

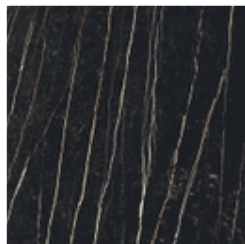

Mat ceramic
Laurent

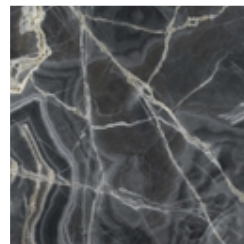

Glossy ceramic
Black Onyx



Glossy ceramic
Mountain peak



Mat ceramic
Augusta

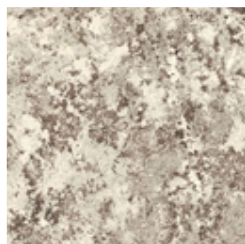

Mat ceramic
Alaska White



Marble
Calacatta

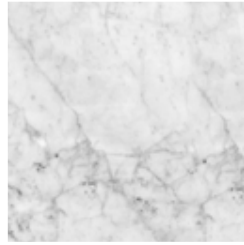

Marble
Carrara

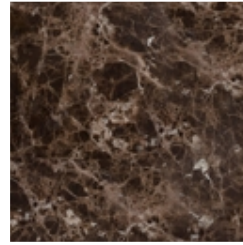

Marble
Emperador



Marble
Fior di bosco

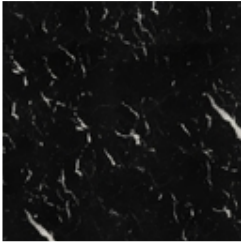

Marble
Marquinia

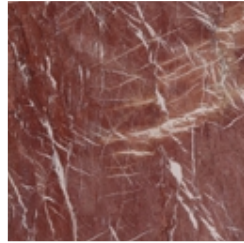

Marble
Rosso Carpazi

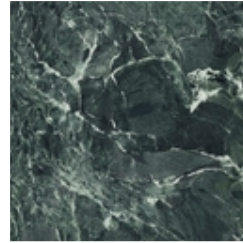

Marble
Saint Denis

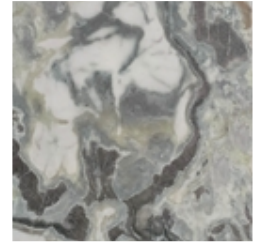

Marble
Dover White



Marble
Travertino Romano

Round top



Glass
Smoked



Glass
Bronzed



Solid wood
Brushed coal oak

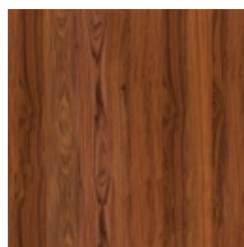

Solid wood
American walnut



Marble
Calacatta

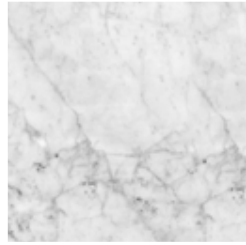

Marble
Carrara

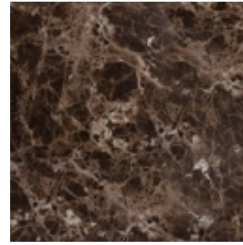

Marble
Emperador



Marble
Fior di bosco

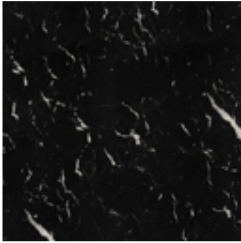

Marble
Marquinia

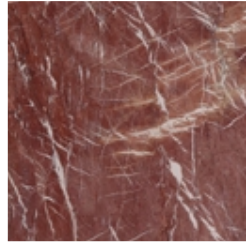

Marble
Rosso Carpazi

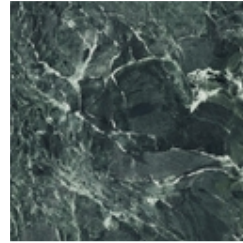

Marble
Saint Denis



Marble
Travertino Romano

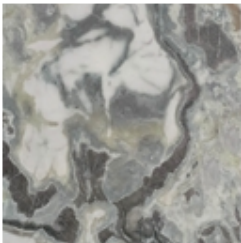

Marble
Dover White

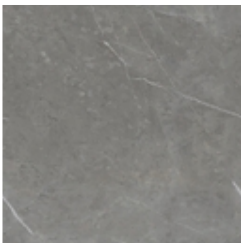

Mat ceramic
Ardesia grey

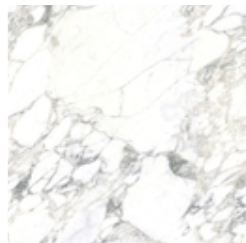

Glossy ceramic
Calacatta



Silk finish ceramic
Calacatta macchia vecchia

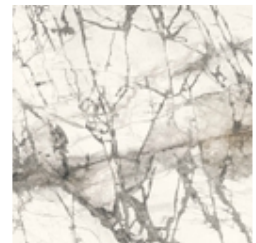

Glossy ceramic
Imperial grey

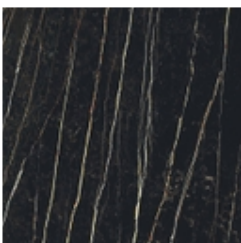

Mat ceramic
Laurent

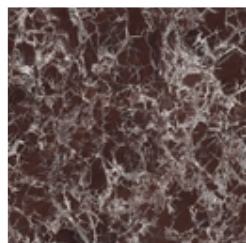

Glossy ceramic
Rosso imperiale

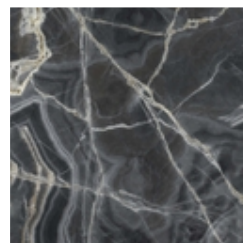

Glossy ceramic
Black Onyx

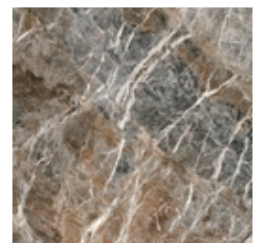

Glossy ceramic
Mountain peak

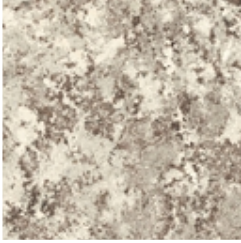

Mat ceramic
Alaska White



Mat ceramic
Augusta

Base



Solid wood
Coal ash

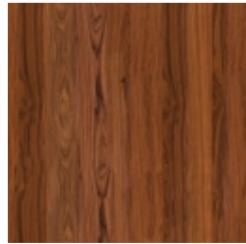

Solid wood
American walnut

Base inserts

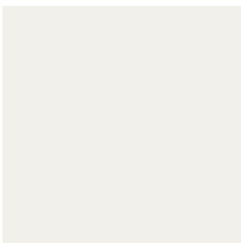

Painted metal
Mat white



Painted metal
Supreme anthracite

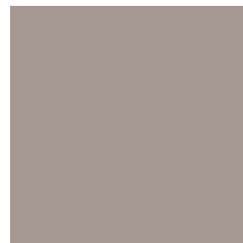

Painted metal
Mat dove grey



Painted metal
Mat black

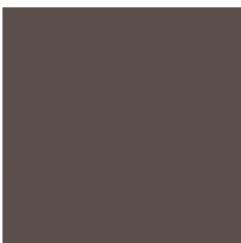

Painted metal
Mat brown

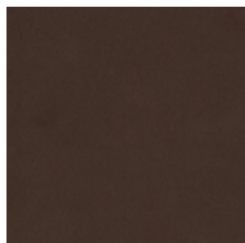

Painted metal
Mat bronze

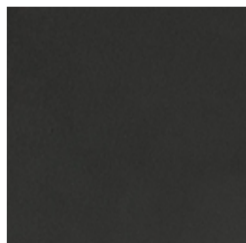

Painted metal
Mat lead



Painted metal
Mat pearl gold



Painted metal
Mat brass



Painted metal
Mat copper



Metal finish
Steel

Materials, fabrics, leathers, colors and finishes are approximate and may slightly differ from actual ones. You can find the complete collection of Bonaldo fabrics and leathers on the website <https://bonaldo.biz>